



WORLDWIDE ELECTRIC MOTOR DATA SHEET

IXPEWWE15-36-254T



HORSEPOWER	15		
RPM / POLES	3600 / 2		
VOLTAGE / PHASE	230 / 460 V / 3		
FRAME	254T		
ENCLOSURE / DEGREE OF PROTECTION	TEFC / IP55		
FREQUENCY	60 HZ Suitable For 50 HZ Operation With 1.0 SF		
FULL LOAD SPEED	3538 RPM		
SERVICE FACTOR	1.15 SF		
INSULATION CLASS	F		
FULL LOAD AMPS	33.0 / 16.5 A		
LOCKED ROTOR AMPS (STARTING)	232 / 116 A		
NO LOAD CURRENT			
NEMA CODE LETTER	G		
EFFICIENCY / POWER FACTOR	<u>LOAD</u>	<u>EFF.</u>	<u>P.F.</u>
	100%	91.0%	0.86
	75%	90.0%	0.87
	50%	89.0%	0.82
DUTY CYCLE	S1 / Continuous		
TORQUE	<u>FULL LOAD</u>	<u>LRT</u>	<u>BDT</u>
	22.4 lb.ft.	130%	200%
SLIP	1.72%		
NEMA DESIGN	B		
MOMENT OF INERTIA			
NUMBER OF STARTS (Hot / Cold)	1 Hot / 2 Cold (Per Hour)		
MAX. AMBIENT TEMPERATURE	40° C		
MAX. ELEVATION	3300 Ft. Above Sea Level		
TEMPERATURE RISE (At Full Load)	80° C		
DE BEARING	6309		
ODE BEARING	6309		
GREASE TYPE	Mobil Polyrex EM		
MOUNTING	F1		
ROTATION	Bi-Directional		
APPROXIMATE WEIGHT	401 lbs.		
TEMPERATURE CODE AT 40°C AMBIENT	T3C		
TEMPERATURE CODE AT 55°C AMBIENT	T2C		
AREA CLASSIFICATION	Class I, Division I, Groups C & D		
	Class II, Division I, Groups F & G		
INVERTER RATING	5:1 CT / 10:1 VT PWM Type		





WORLDWIDE ELECTRIC MOTOR DRAWING

IXPEWWE-254T

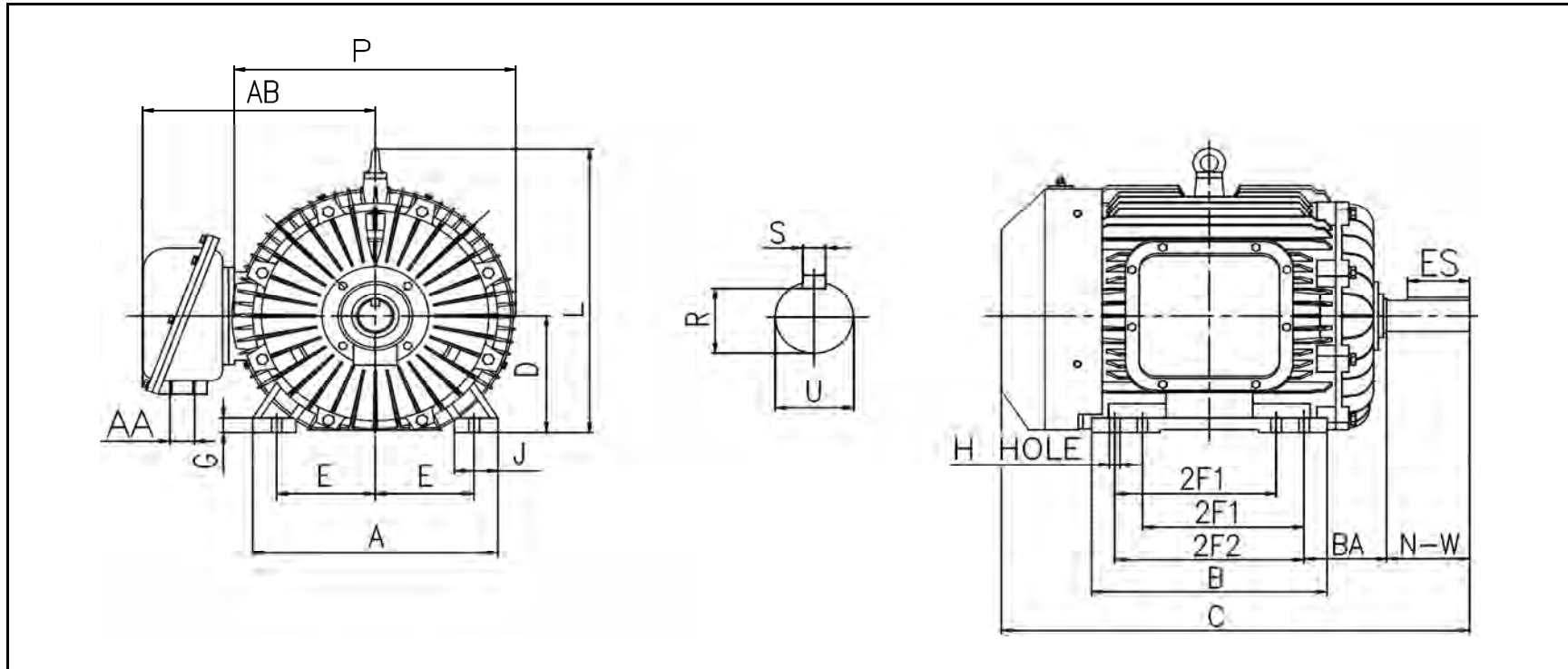

MOUNTING					A	B	C	D	G	J
E	2F1	2F2	H	BA						
5	8.25	10	0.53	4.25	12.4	12.4	25.2	6.25	0.87	2.76

				KEY	KEYSEAT	SHAFT		
L	P	AA	AB	ES	S	R	N-W	U
15.55	14	1.25	13.58	2.91	0.375	1.416	4	1.625

ALL DIMENSIONS IN INCHES

REVISED - 09/16/16