

DATA SHEET

Premium Efficiency Motor: **LAM10-36-215T**,

60 Hz

WorldWide Electric Corporation

1 (800) 808-2131

Worldwideelectric.net



Document Generated: 5-Apr-2021

Document ID:

Customer:

MOTOR INFORMATION

HP	10
RPM	3600
Phase	3
Frequency	60 Hz
Voltage	208-230/460
Frame Size	213/5T
Enclosure	TEFC
Degree of Protection	IP55
Service Factor	1.25
Poles	2
Full Load Speed	3512
Insulation Class	F
Temp Rise	80°C
NEMA Code Letter	H
Duty Cycle	S1 / Continuous
Slip	2.46%
NEMA Design	B
Moment of Inertia	0.522 lb.ft. ²
Locked Rotor Time (Hot)	12 seconds
Sound Pressure Level	91 dB(A)
Number of Starts	2 Cold/1 Hot
Max Ambient Temperature	40°C
Max Elevation	1000 m.a.s.l (3300 f.a.s.l)
Mounting	F1
Rotation	Bi-Directional
Area of Classification	Class 1 Division 2 Groups A,B,C,D T3B
Inverter Rating	10:1 CT / 20:1 VT
Standard	NEMA MG-1
Approvals	UL, CE, IEEE45

EFFICIENCY/POWER FACTOR

LOAD	EFF	P. F.
100%	90.2 %	0.9
75%	91.0 %	0.88
50%	90.2 %	0.82

TORQUE

FULL LOAD	LRT	BDT
14.85 lb.ft.	411 %	471 %

AMPERAGE INFORMATION

	230V	460V
Full Load Amps	23.2A	11.6
Locked Rotor Amps	176.4A	88.2A
No Load Current	5.8A	2.9A
Usable at 208V	25.7 A	

BEARING INFORMATION

DE Bearing	6308 ZZ
ODE Bearing	6306 ZZ
Grease Type	NSK SN7
DE Regreasing Interval	-- Hours
ODE Regreasing Interval	-- Hours
Grease Quantity	--

ADDITIONAL DATA

F2 Suitable	YES
Shaft Material	AISI 1045
Connection Diagram	9 Lead Wye
Approximate Weight	192 lbs.



LOUIS ALLIS MOTOR DRAWING

LAM-213/5T

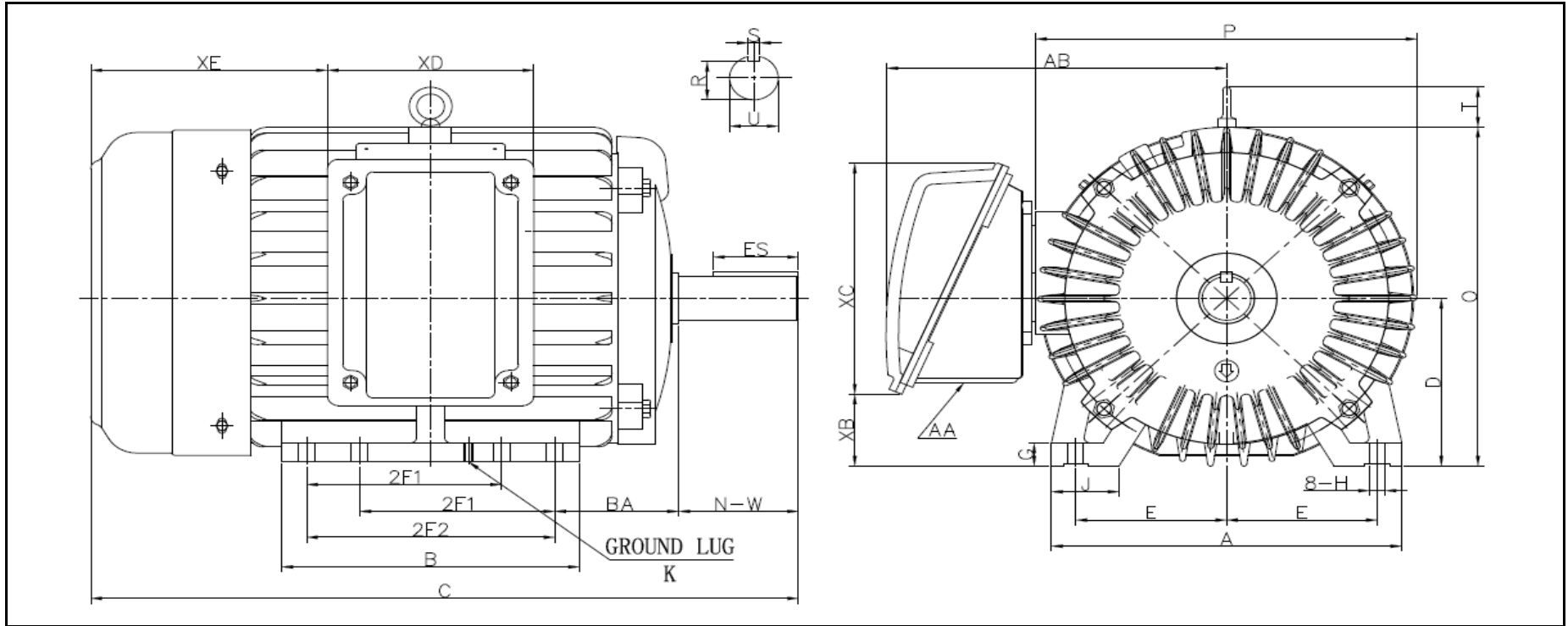

DIMENSIONS - INCHES

MOUNTING					A	B	C	D	G	J	P	O	T	AB
E	2F1	2F2	H	BA										
4.25	5.5	7	0.43	3.5	9.88	8.405	20.27	5.25	0.708	1.91	10.8	10.53	1.72	9.8

SHAFT & KEY				
S	ES	R	N-W	U
0.31	2.41	1.201	3.38	1.375

TERMINAL BOX				
AA	XB	XC	XD	XE
1	2.25	7.2	5.8	5.9

PERFORMANCE CURVES

WorldWide Electric Corporation

1 (800) 808-2131

Worldwideelectric.net



Premium Efficiency Motor:

LAM10-36-215T

Document Generated:	5-Apr-2021	Customer:	
Document ID:			

Motor Type	LAM				
Output Rating (HP)	10	FL Speed	3512		
Full Load Torque	14.85 lb.ft	LRT (%FLT)	411	460 volt FLA	11.6
Rotor Wk ²	0.522 lb-ft ²	BDT (%FLT)	471	230 volt FLA	23.2A

